

Newsmy

S2400 User Manual

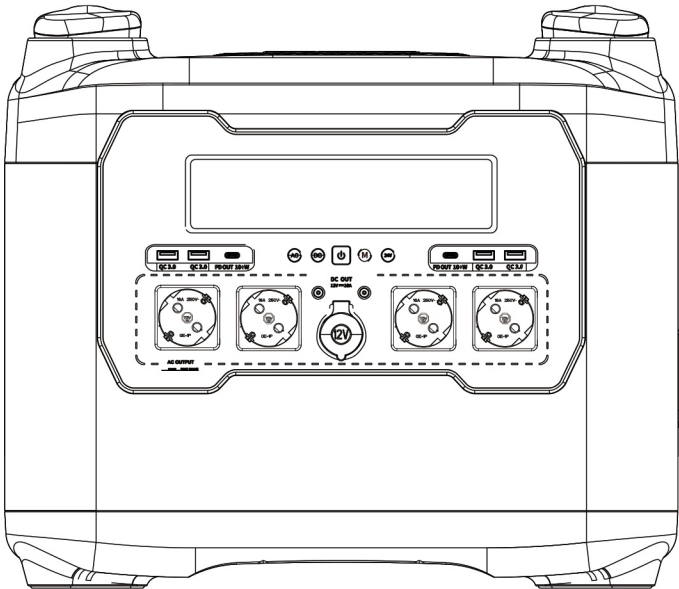

Thank you for choosing our product.

Warm Tips

Please read the instructions carefully before use.

The actual power outlet and adapter may vary depending on the location of customer.

Note: The product has a variety of specifications of the AC output socket, please in kind prevail!

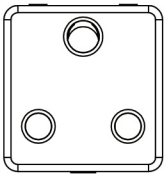

South Africa standard
AC output socket

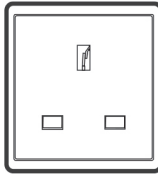

British Standard
AC output socket

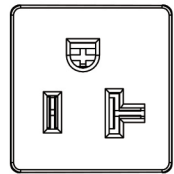

Japanese Standard/
American Standard
AC output socket

Please use S2400 in its operating temperature range. Using S2400 outside of its optimal operating temperature range can push the machine beyond its safe limits. Do not submerge your S2400 in water. It is not waterproof and this will void your warranty. Please keep S2400 upright and do not block the ventilation Fan while using S2400.

Important

What you need to know about LMFP(LiMnxFe1-xPO4) batteries?

LMFP batteries have an extremely long life and superior safety, capable of 2,000 cycles, they are 4-6 times longer than other lithium-ion batteries. Excellent thermal and chemical stability make LMFP batteries safer than other lithium-ion batteries. In addition, LMFP batteries have a lower capacity loss than lithium-ion batteries, making them more suitable for use at high frequencies.

It should be noted that when a LMFP battery is not used for a long time, it automatically enters a dormant state. In this state, the capacity of the battery is much lower than the actual capacity, so you may experience a rapid depletion of power when you first use the product after receiving it - this is not battery damage, but a normal condition that can occur with all LMFP batteries. Please be assured that LMFP batteries are easily activated, and after just 3-5 normal charge and discharge cycles, the battery will be activated and returned to normal capacity. Therefore, if you experience a rapid depletion of power when using the product for the first time, please fully charge and try again.

Because of this characteristic of LMFP batteries, we recommend that it is best to recharge the product every two months, even if you do not use it for a long time.

Product Details

Product Front View

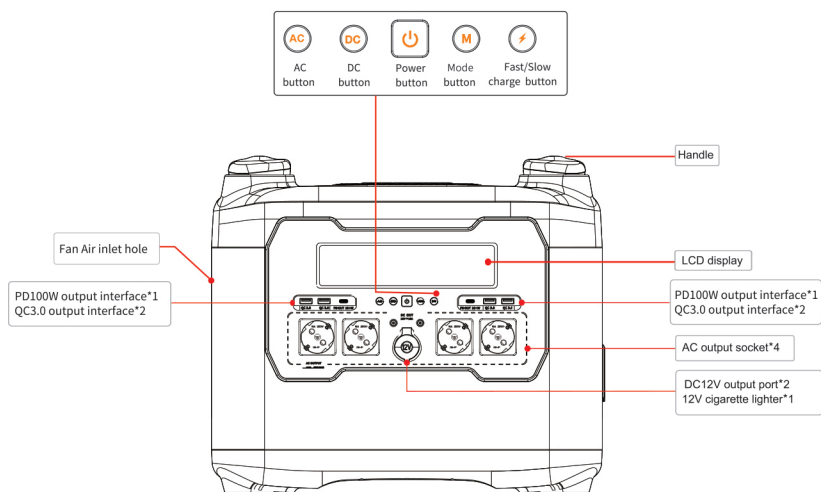

Product Details

Product Right Side View

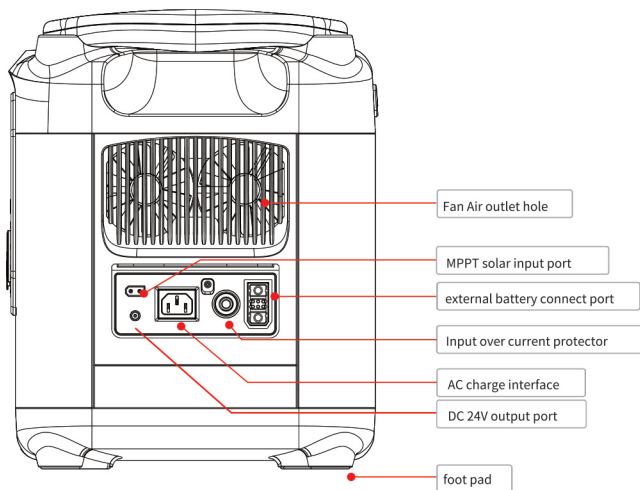



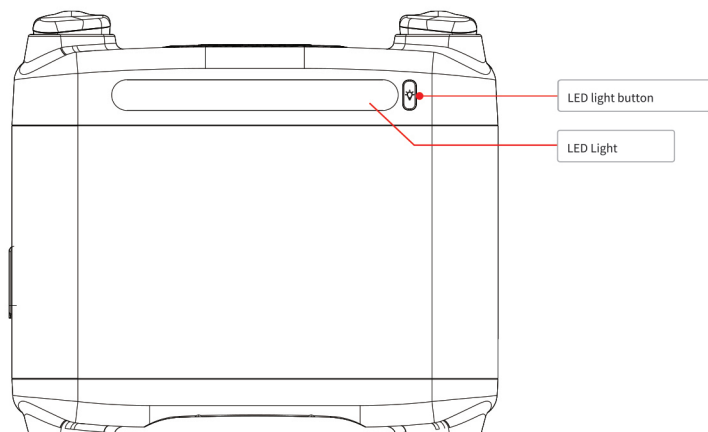



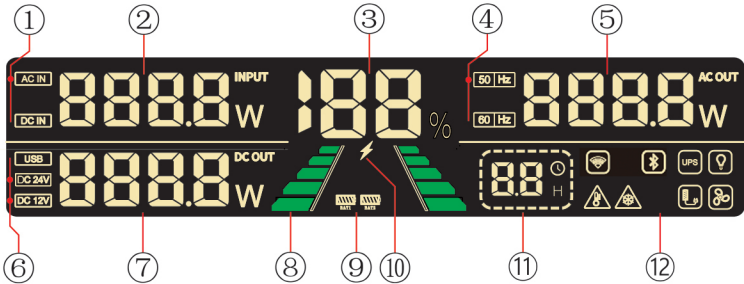

Product Back View



LCD Display Screen Icons



Display Screen Explanation	
①	AC and DC (Solar) Input Icons: These icons remain lit when the device is charging.
②	Charging Input Power Display: When charging with both AC and DC simultaneously, the power is displayed as the combined total.
③	Battery Percentage Display
④	AC Output Frequency Display
⑤	AC Output Power Display
⑥	USB/DC12V/DC24V Output Icons: They remain illuminated when these output ports are activated.
⑦	Direct Current Output Power Display: When USB/DC12V/DC24V outputs are active simultaneously, the power is displayed as the combined total.
⑧	5-Bar Battery Indicator
⑨	Expansion Battery: A constant illumination indicates that the corresponding expansion battery is connected to the main machine.
⑩	Fast Charging Indicator: When this icon is displayed, it indicates that the charging is in fast charging mode. If this icon is not displayed, it means the device is in slow charging mode.
⑪	Remaining usage time
⑫	 UPS Icon: This icon remains lit when the UPS function is activated.
	 LED Light Indicator Icon: This icon remains illuminated when the LED light is turned on.
	 High Temperature Warning Icon: This icon flashes when the set high-temperature protection threshold is reached.
	 Low Temperature Warning Icon: This icon flashes when the temperature falls below the set protective temperature threshold.
	 Successful Expansion Battery Connection Icon: This icon remains lit when an expansion battery is successfully connected to the main unit.
	 Fan Icon: This icon remains illuminated when the fan is turned on.
	 Wi-Fi Icon: It flashing during network setup, stays on steadily after WIFI connection.
	 Bluetooth Icon: This icon steady when Bluetooth is connected.

Product Function Introduction

1.This product is compact in size, making it easy to carry, and it is highly versatile for use in various locations.



Long-distance Travel



Camping



Wild Adventure

2.This product features a 220V AC inverter function, providing emergency power for household appliances such as computers, refrigerators, rice cookers, lighting, and more.



Fan



Rice Cooker



Lighting

3.This product also includes a DC output function, capable of supplying power to digital devices like smartphones, laptops, watches, toys, and car accessories. It supports USB Quick Charge 3.0 and PD charging, features DC output ports, and a cigarette lighter socket, enabling it to power 12V and 24V car devices.



Laptop



Tablet



Smart Phone

4.This product is suitable for outdoor use and comes with a built-in high-capacity safety battery. It features a high-intensity LED lighting function with various modes, including constant brightness, dimmer brightness, fast flashing, and SOS distress signal. (Please note that this product is not waterproof and should not be used in rainy, snowy, or damp conditions.)



Safe Use



Emergency Lighting



Outdoor Energy Storage

Detailed Product Function Explanation

1. Product Power On, Power Off, and Screen Off

- 1.1 Short press the "POWER button" to power on;
- 1.2 While the device is powered on, short press the "POWER button" to turn off the screen;
- 1.3 While the device is powered on, press and hold the "POWER button" for 2 seconds to power off

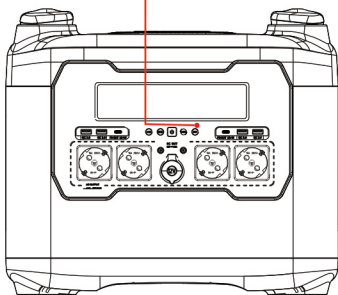

2. How to Use LED Lighting

- 2.1 In the powered-on state, press and hold the "LED Light Button" for 2 seconds to turn on the LED light. The LED illumination icon will light up on the display screen.
- 2.2 Short press the "LED Light Button" to toggle between the LED light operating modes: Constant Brightness, Dim Brightness, Rapid Flash, Slow Flash, and Off.

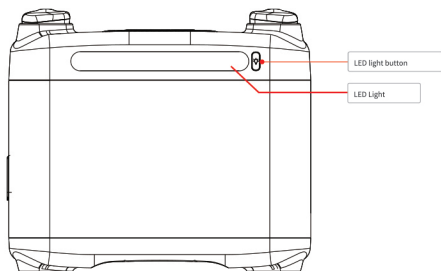

3.How to Use the DC Output Function

In the powered-on state, press the "DC" button briefly to activate the USB output, Type-C output, DC 12V output, and DC 24V output. Press the "DC" button again briefly to deactivate these outputs. When the USB, DC12v ,DC24V output ports are working at the same time, the output power on the display is superimposed

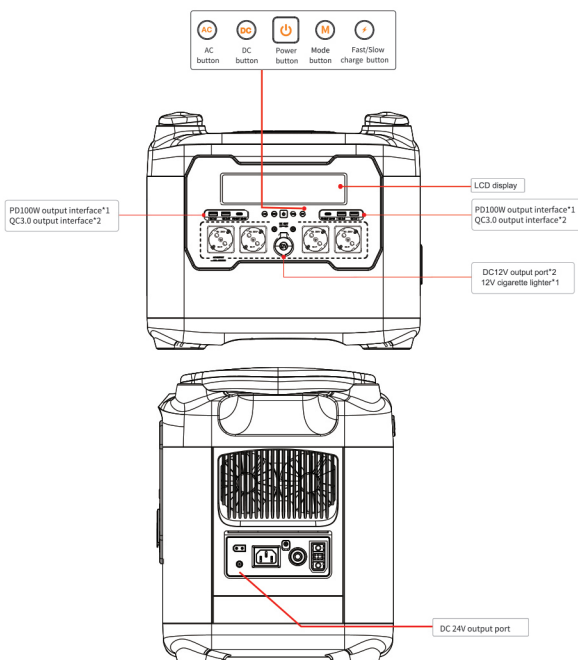

4.How to Use the AC Output Function

After the product has been powered on, press and hold the "AC Button" for 3 seconds to activate the 220V AC output. Then, plug in your devices that require AC power into the AC power output interface to use them. When you no longer need the AC output function, press and hold the "AC Button" for 3 seconds to turn off the 220V AC output, and then unplug the devices.

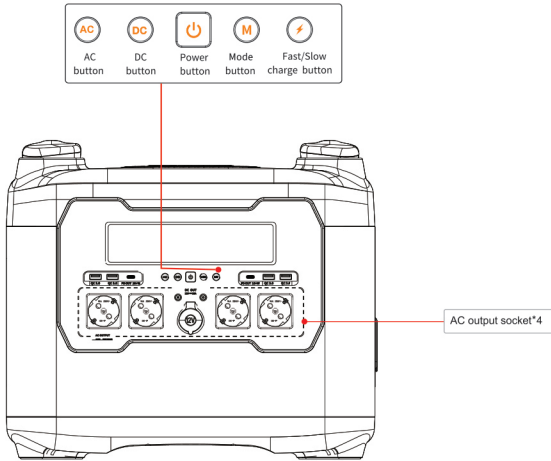

5.How to Use the Expansion Battery Function

This S2400 is equipped with an expansion port, and you have the option to purchase the B2000 as an expansion kit, effectively doubling your power station's battery capacity.

The expansion kit includes a battery pack and an expansion cable. When you wish to use the expansion kit, simply connect your S2400 to the B2000's expansion port using the expansion cable.

Note: Ensure that the main machine is powered off when connecting the expansion battery.

6.How to Charge Your Product

1 Charging via the AC Input Port

At home, you can use the provided AC power cord to connect to the mains power for charging at a power rating of 2000W. When charging via AC, the fast charging icon will light up. (Please note that the maximum AC charging power of this unit is 2000W, and charging power may decrease when the battery is low, nearing full charge, or due to environmental temperature fluctuations, which is considered a normal phenomenon.)

While charging via AC, press and hold the "Fast/Slow Charge Button" for 3 seconds to switch the charging mode to slow charging, with a charging power of 500W.

Note: Please use the provided charging cable for charging and ensure you use a socket or power strip with a rating of at least 10A. If your power strip socket is burnt or deformed, please refrain from using it.

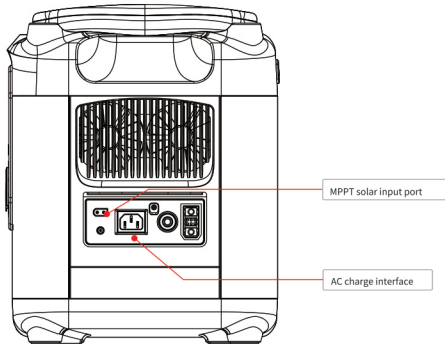

2 Charging via the solar input port

This unit comes equipped with an XT60 solar input port, supporting DC 12V-100V, with a maximum charging capacity of 1200W.

The AC input port and XT60 input port can be charged simultaneously, with a maximum combined charging power of 3200W.

7.How to Use the UPS Function

UPS Standard Mode: While charging via AC, press and hold the "AC Button" for 3 seconds. The "UPS" icon on the display screen will light up, indicating that the UPS function is activated. When you unplug the charging cable or experience a power outage, the unit will switch to AC output mode to provide power to your appliances within 20 seconds.

UPS Forced Mode: While the unit is powered on, press the "Fast/Slow Charge Button" consecutively 5 times. The "UPS" icon on the display screen will light up, indicating that UPS Forced Mode is activated. In this mode, whenever you connect AC power, the AC output will automatically activate in any scenario. If you wish to deactivate UPS Forced Mode, simply press the "Fast/Slow Charge Button" 5 times again while the unit is powered on.

Note: Due to variations in electrical devices, the UPS function cannot guarantee compatibility with all appliances. If your devices require UPS functionality, please conduct a trial to ensure they can be used with it.

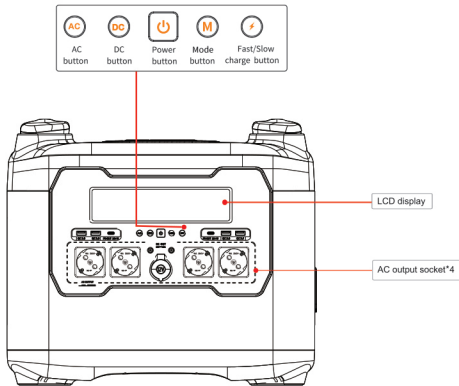

Micro-Inverter Mode

1.How to Use the Micro-Inverter Mode to Connect to the Power Grid

While the machine is powered on, press and hold the "M" Button for 3 seconds.The DC output power display section onthe screen will show the micro-inverter mode code: 001. Thisindicates that the machine has entered the micro-invertermode. Connect the machine's AC input port to the power gridusing the provided AC cable, then press and hold the "AC Button" for another 3 seconds to activate the AC output.

Note: Before using the micro-inverter mode, ensure that thepower grid is operational, and the machine's AC input port isconnected to the power grid via the provided AC cable.

Note: In the micro-inverter mode, the machine can output a maximum of 230V - 800w power to the power grid. Please ensure that the socket connected to the machine and the wires connected to the socket can withstand this power to preventany safety accidents.

2.How To Use The Full Power Output Function to Achieve Whole House Power Supply to Connect to The Power Grid

While the machine is powered on, press and hold the "M" Button for 3 seconds.The DC output power display section onthe screen will show 001.Then, press and hold the "M" Buttonagain for 3 seconds to display the full power output mode code:002.This indicates that the machine has been set to the fullpower output mode.After connecting the machine's AC inputport to a household power outlet using the provided AC cable,press and hold the "AC" Button for another 3 seconds to activate the machine's full power output mode.

Note: Before using the full power output mode, please ensure that the power grid is in a blackout state, and disconnect the main power switch inside your home. Connect the machine's AC input port to the power grid using the provided AC cable.

Note: When using the full power output mode, first plug in the charging cable to a wall socket inside your home, and then turn on the machine. The machine's rated output power is: 230V, 2400W. Please ensure that the socket connected to the machine and the wires connected to the socket can withstand this power to prevent any safety accidents.

3.How to Exit Micro-Inverter Mode and Full Power Mode to Enter Normal Mode

Exiting from Micro-Inverter Mode to PPS Mode

First, press and hold the "AC" Button for 3 seconds to deactivate the grid-connected output. Then, press and hold the "M" Button for 3 seconds. The DC output power display area on the screen will show: 002. Press and hold the "M" Button again for 3 seconds. The DC output power display area on the screen will be blank, indicating that the machine has entered the normal mode state.

First, press and hold the "AC" Button for 3 seconds to deactivate the full power output. Then, press and hold the "M" Button for 3 seconds. The DC output power display area on the screen will be blank, indicating that the machine has entered the normal mode state.

4.Connect And Control Via WIFI/Bluetooth

Download and Install APP

Download and install the "Wonderfree" app (For North America: "Landscape" app) from your desired app store. (Available on all major app stores including Apple store, Google store, Android store, ect.).

Connect Devices

1.Application Permission Acquisition: Open the APP, give permission to "Location" and "Nearby Devices" (the APP will give you a prompt accordingly).

2.Open the portable power station by long pressing the open button, then press and hold the DC button on the power station for 5 seconds to enter the pairing state.

3.Click "Add a device"-"Detect Nearby Devices" on APP to start searching for nearby devices. The device "S2400P_****" will be displayed, then click the "Add" icon to the right of the device information to match.

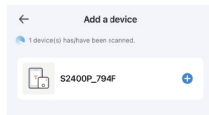
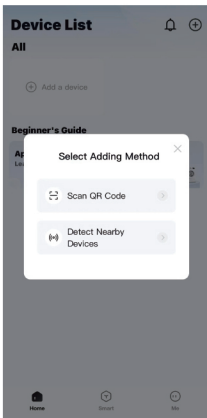

5.Control Panel and Functions

1.Input Power Status

Real-time display of charging wattage for AC Charging Input Power/DC Charging Input Power/Solar Panel Charging Input Power

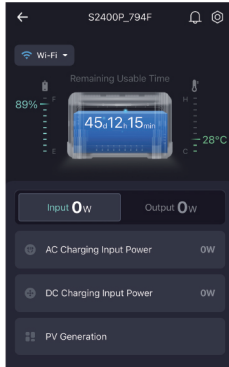

2.Output Power Status

(1)Real-time display of discharge wattage for AC Output Power/USB Output Power/Type-C Output Power/DC Output Power

(2)Control AC Output Power and DC Output Power by on and off button



(3)Control LED by on and off button, switch LED modes

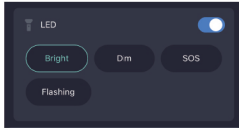

3.Switch "Mobile Energy System" modes

“Others” - “ Operating Mode”

There are 3 modes to be chosen: Micro-Inverter Mode/Full Power Generation Mode/PPS Mode



4.Adjust On-Grid Power

“Others” - “ On-Grid Power”

Adjustable on-grid output power: 200W/300W/600W

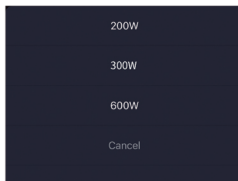

5. Minimum Power Protection

“Others” - “SOC Reserve Capacity”

Set a value between 5% and 95%, when the power reaches this value, it will cut off the power for protection.

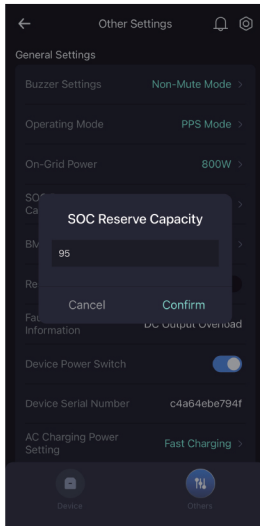

Specification

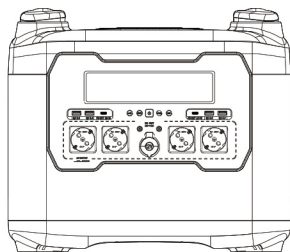

Model	S2400
Battery Capacity	2047.5Wh,48.75V 42Ah
DC Output	24V=5A
DC Output	12V=10A
Cigarette Lighter Output	12V=10A
USB Output	QC3.0*4 5v3A,9V2A,12V 1.5A
Type-C Output	5V,9V,12V,15V = 3A/20V = 5A(PD100W)
Mppt Input	12-100V 1200w (MAX) Current: 20A (MAX)
AC Output	110V 50Hz/60Hz or 230V 50Hz 2400W
AC Input	110V 50/60Hz 1500W or 230V 50Hz 2000W
Working Temperature	-20-60°C
UPS	20Ms
WIFI	2.412~2.484GHz 16dBm
Bluetooth	2.402~2.480GHz 6dBm

Product parameters

1 Charging via the AC Input Port

Battery Capacity : Refer to the nameplate

AC Input : Refer to the nameplate

AC Output Voltage : Refer to the nameplate

AC Output Power : Refer to the nameplate

Solar Input Power : 12V-100V 1200w(max)

DC/ Cigarette Lighter Output: 12V 10A(120W max); 24V 5A

PD Output : 5V 3A/ 9V 3A/12V 3A /20V 5A (PD100W)

USB Output : 5V 3A / 9V 3A/12V 1.5A(QC3.0)



WiFi: 2.412~2.484GHz 16dBm

Bluetooth:2.402~2.480GHz 6dBm

Fan working condition :

Work condition		Cool fan
Power	Inverter Temperature	
$P < 600W$		No fan
$P > 600W$	$T < 45^{\circ}C$	No fan
	$45^{\circ}C < T < 55^{\circ}C$	Level 1
	$55^{\circ}C < T < 65^{\circ}C$	Level 2
	$65^{\circ}C < T < 70^{\circ}C$	Level 3
	$T > 70^{\circ}C$	Level 4
$P > 2100W$		Level 4

Accessory List

Main machine * 1	
AC charging cable *1	
User manual * 1	

Cautions:

1. Always operate or store the unit in accordance with specified temperature range.
2. DO NOT expose the unit to fire, liquids, sweat, dirt or other contaminants, as that may cause the battery to explode or leak flammable liquid or gas.
3. DO NOT store the unit with hazardous materials including flammables, explosives, radioactive materials, etc.
4. DO NOT place the unit on an unstable or tilted surface.
5. Make sure the place where you are using the unit is well ventilated and spacious.
6. Keep away from children and pets.
7. Check if the connectors of all connection cables are locked before use.
8. During use or while charging, if the device experiences slight heating, it is considered a normal phenomenon and not a malfunction.
9. DO NOT modify, attempt to insert foreign objects into the battery, or immerse or expose it to water or other liquids. Batteries may explode if damaged.
10. Battery fluid is corrosive and may be toxic. If a battery leaks, keep the leaked fluid from touching your skin, eyes, clothes, or other surfaces. Immediately flush the affected areas with water, or seek medical help.
11. DO NOT ignore those warning signs on components or products made by manufacturers.
12. DO NOT dismantle, cut, crush, puncture, or otherwise damage the unit in any way.
13. DO NOT insert foreign objects into the fan, vents, ports, or other openings.
14. NEVER use a damaged battery or component. Improper use or misuse of damaged batteries may cause damage to your device or injury to yourself as a result of battery fluid leakage, fire, overheating, or explosion.
15. Use approved battery and accessories ONLY. Improper use, or use of unapproved or incompatible batteries or components may result in a risk of fire, explosion, or other hazards, and may invalidate any approval or warranty.
16. Use dry powder fire extinguisher in case of fire.
17. Please don't try to disassemble the product and only professional technical staffs are allowed to disassemble it. Or it will cause electric shock, fire or explosion such unknown dangers.



Maintenance

- 1 When not using the unit for extended periods of time, power off the unit and disconnect the AC adapter from the outlet.
- 2 Charge the unit to 80% SOC every 3-6 months for long-term storage.
- 3 Clean the unit with a dry cloth gently and carefully.

Fault Code Explanation:

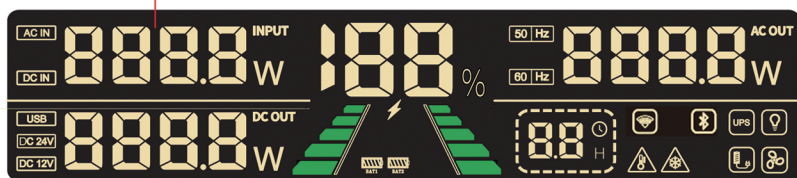
Fault Code



Fault Code	Reason	Solution
E01	DC output overload	Disconnect the devices in the DC connection, short press the DC button to switch on the DC output function.
E02	DC output short-circuit	Disconnect the devices in the DC connection, short press the DC button to switch on the DC output function.
E03	AC output/input overload or short-circuit	Disconnect the AC output device, short press the AC button to switch on the AC function.
E04	AC output over-temperature	Disconnect the device in the AC connection. When the working temperature returns to the normal level, the fault code will be removed.
E05	AC output undervoltage	
E06	AC output overvoltage	
E07	PD output overload or short-circuit	Disconnect the devices in the PD connection and briefly press the USB button
E08	USB-A output overload or short-circuit	Disconnect the devices in the PD connection and briefly press the USB button
E09	USB-A output overload or short-circuit	Disconnect the device in DC connection. Once the voltage turns to normal, the fault condition will be removed automaticall

Fault Code	Fault Content	Fault Solution
E10	DC charging low-voltage	Disconnect the device in DC connection.Once the voltage turns to normal,the fault condition will be removed automaticall
E11	AC input low voltage	After the AC input voltage is restored to the normal voltage range,re-insert the charging port.
E12	AC input high voltage	After the AC input voltage is restored to the normal voltage range,re-insert the charging port.
E13	Battery over-temperature	Disconnect all the devices.When the working temperature returns to the normal level,the fault code will be removed.
E14	Battery low-temperature	Disconnect all the devices.When the working temperature returns to the normal level,the fault code will be removed.
E15	Battery over temperature during charging/discharging	Disconnect all the devices.When the working temperature returns to the normal level,the fault code will be removed.
E183	Expansion pack battery connection failure	Turn off the product,unplug and plug the expansion pack battery connection cable again then restart
E199	Grid connection failure, no grid power.	After connecting to the grid power, the fault code will be automatically cleared.
E201	Battery Capacity Below Preset Minimum, Grid Connection Failed.	When the battery capacity returns to the preset minimum + 5%, the error code will be automatically cleared.
E202	Grid power detected in Full Power Mode.	Detected grid power outage, the error code is automatically cleared.

For further assistance, do not hesitate to contact customer service at **support@newsmypower.com**

Learn more about us, please check out

<https://www.newsmypower.com>



Customer Service



MADE IN CHINA

EN-23